



control solutions
TERACOM



TCG120 GSM/GPRS controller

Version 1.13 / January 2020

USER MANUAL

1. Short description

TCG120 is a GSM-GPRS remote monitoring controller for distributed IO monitoring and control. The controller has 2 digital inputs, 2 analog inputs, and 1-Wire interface. The controller supports up to 4 Teracom humidity and temperature 1-Wire sensors. The device has 2 relays with normally open and normally closed contacts.

The relays can be activated either remotely (via SMS or HTTP API command) or locally - from the status of the monitored parameters. Only one parameter can control the relay at the same time, but for each parameter, an email or SMS can be sent on an alarm condition.

TCG120 may periodically send data to a remote server, which makes it suitable for client-server monitoring and control systems.

2. Features

- Quad-bands connectivity;
- Setup via USB, SMS and HTTP API;
- 2 digital inputs with "dry contact" and "logic level" modes;
- 2 analog inputs with 0 to 60 VDC range;
- 2 relays with NO and NC contacts;
- TST1xx, TST2xx and TSH2xx temperature and humidity 1-Wire sensors support;
- SMS alarm alerts to 5 numbers;
- Email alarm alerts to 5 email recipients, with TLS 1.2 support;
- Single call control from up to 100 numbers;
- Periodical HTTP post with current status in XML or JSON file to remote server;
- HTTP API commands;
- Firmware update over USB or GPRS.

3. Applications

- Remote control
The relay outputs can be controlled with SMS, HTTP command or by a single call from an authorized number.
- Humidity and temperature control
TCG120 supports TST1xx, TST2xx and TSH2xx temperature and humidity- temperature 1-wire sensors. The relay outputs can be controlled from the value of the measured parameters.
- Status reporter
SMS and E-mail alerts can be sent to the authorized recipients. The alerts can be triggered if some of the measured parameters (temperature, humidity, analog inputs, and digital inputs) are in the alarm state.
- SCADA systems
TCG120 be easily integrated into SCADA systems. The periodical HTTP post is suitable for client-server configurations.

4. Specifications

- Physical characteristics
Dimensions: 107 x 72 x 32 mm
Weight: 130 g
Mounting: wall
- Environmental limits
Operating Temperature: 0 to 40°C
Storage Temperature: -25 to 60°C
Ambient Relative Humidity: 5 to 85% (non-condensing)
- Standards and Certifications
Safety: EN 60950-1:2006+A11:2009+A1:2010+A12:2011+A2:2013; EN 61010-1:2010
EMC: EN 55022:2010, EN 55024:2010, EN 61000-3-2:2014, EN 61000-3-3:2013
EN 301489-1 V1.9.2, EN 301489-7 V1.3.1
RFSU: EN 301511 V9.0.2
Green Product: RoHS
- Warranty
Warranty period: 3 years
- Power requirements
Input Voltage: 8 to 32 VDC
Input Current: 140 mA @ 12 VDC
- Cellular interface
Standards: GSM/GPRS
Bands: 850/900/1800/1900 MHz
GPRS multi-slot class: 12, 1~12 configurable
GPRS terminal device class: Class B
Compliant to GSM Phase 2/2+: Class 4 (2W@850/ 900MHz), Class 1 (1W@1800/1900MHz)
SIM card size: Standard
Antenna connector: SMA-F
- Analog inputs
Isolation: Nonisolated
Type: Single ended
Resolution: 10 bits
Input Range: 0 to 60 VDC
Accuracy: ±1%
Sampling Rate: 500mS per channel (averaged value of 500 samples)
Input Impedance: 1 mega-ohms (min.)

- Digital inputs
Isolation: Nonisolated
Type: Dry contact and logic level
Minimum high-level input voltage for digital inputs: +2.5VDC
Maximum low-level input voltage for digital inputs: +0.8VDC
Maximum input voltage for digital inputs: +5.5VDC
Sampling rate: 10mS
Digital filtering time interval: 30mS
- Relay outputs
Type: Form C (N.O. and N.C. contacts)
Contact current rating: 3 A @ 24 VDC, 30 VAC (resistive load)
Initial insulation resistance: 100 mega-ohms (min.) @ 500 VDC
Mechanical endurance: 10 000 000 operations
Electrical endurance: 100 000 operations @ 3 A resistive load
Contact resistance: 50 milli-ohms max. (initial value)
Pulse output: 0.1 Hz at rated load
- 1-Wire interface
Output voltage: 5.0 ± 0.3 VDC
Maximum output current: 200 mA
- Internal FLASH memory
Endurance: 100 000 cycles (Every relay status and settings change is a memory cycle)

5. Installation

This device must be installed by qualified personnel. The installation consists of mounting the device, connecting to the GSM network, connecting inputs and outputs, providing power and configuring via a web browser. This device must not be installed directly outdoors.

Attention! Before installing the SIM card in the card slot, please ensure that the PIN code is disabled.

5.1. Mounting

TCG120 should be mounted in a clean and dry location on a not flammable surface. Ventilation is recommended for installations where the ambient air temperature is expected to be high.

Mount the device to a wall by using two plastic dowels 8x60mm (example Würth GmbH 0912 802 002) and two dowel screws 6x70mm (example Würth GmbH 0157 06 70). Attach the screws to the surface vertically. See Appendix C, fig. 1 for mechanical details.

Maintain spacing between adjacent equipment. Allow 50 mm of space on all sides, as shown in fig.2 in Appendix C, this provides ventilation and electrical isolation.

5.2. Connectors

Attention! Disconnect power supply before wiring.

The correct wiring procedure is as follows:

- Make sure power is turned off;
- Make wiring connections to the terminals;
- Apply power.

It is recommended to test and configure TCG120 without any controlled device.

Make sure that wires are properly attached to the terminals and that the terminals are tightened. Not proper wiring and configuration can cause permanent damage of TCG120 or the equipment to which it is connected or both. Inputs and outputs locations are shown below:



- Connector 1** – Power - 2.1x5.5mm connector, central positive
- Connector 2, Pin1** - Digital input 1 (**Din1**)*
- Connector 2, Pin2** - Digital input 2 (**Din2**)*
- Connector 2, Pin3** - Ground
- Connector 2, Pin4** - Analog input 1 (**Ain1**)
- Connector 2, Pin5** - Analog input 2 (**Ain2**)
- Connector 2, Pin6** - Ground
- Connector 2, Pin7** – 1-Wire data
- Connector 2, Pin8** – 1-Wire power supply
- Connector 3** – mini USB
- Connector 4** – SIM card holder
- Connector 5** – GSM Antenna
- Connector 6, Pin1** – NC Relay2
- Connector 6, Pin2** – COM Relay2
- Connector 6, Pin3** – NO Relay2
- Connector 7, Pin1** – NC Relay1
- Connector 7, Pin2** – COM Relay1
- Connector 7, Pin3** – NO Relay1

* Operating mode is selected by jumper DI1/DI2 - closed for “dry contact” and open for “logic level”. By default, jumpers are closed.

5.2.1. Power supply connection

TCG120 is designed to be supplied by adapter SYS1308-2412-W2E or similar, intended for use in the conditions of overvoltage category II. The power supply equipment shall be resistant to short circuit and overload in the secondary circuit.

When in use, do not position the equipment so that it is difficult to disconnect the device from the power supply.

5.2.2. Digital inputs connection

Attention! Digital inputs are NOT galvanic isolated.

The TCG120 digital inputs can be used in two modes – “dry contact” and “logic level”. The mode is determined by the jumper, close to the corresponding input. To change the operation mode, the plastic enclosure must be opened. Closed jumper determines “dry contact” mode while open “logic level”. By default digital inputs are in “dry contact” mode.

In “dry contact” mode digital inputs can be used to monitor the state of a discrete device – door contact switch, push button, PIR detector etc.

The following picture illustrates how a dry contact switch can be connected to the input (or inputs) of TCG120. One side of the contact is connected to “Digital In” and the other side is connected to “GND” terminals.

The maximum cable length for a digital input should be up to 30 meters.



5.2.3. Analog inputs connection

Attention! Analog inputs are NOT galvanic isolated.

Analog inputs of TCG120 can be used for monitoring of DC voltage up to 60VDC. They can be connected directly to batteries, solar panels, power supplies etc.

Built-in functionality “Multiplier”, “Offset” and “Dimension” for every analog input gives the possibility to monitor sensors with analog outputs and see directly the measured parameter. It is also possible to monitor voltages higher than 60 VDC with external resistive dividers.

The following picture illustrates how a battery can be connected to the analog input of TCG120. One side of the contact is connected to “Analog In” and the other side is connected to “GND” terminals.

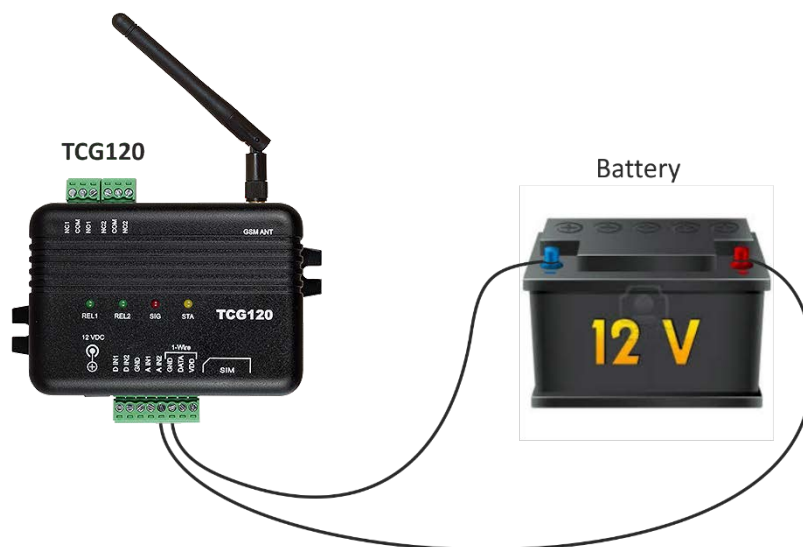

The maximum cable length for a digital input should be up to 30 meters.

5.2.4. Sensor connection

The device supports TST1xx, TST2xx and TSH2xx temperature and humidity-temperature sensors. Up to 4 1-Wire sensors can be connected to the controller.

1-Wire is a registered trademark of Maxim Integrated Products, Inc. It is designed to connect several sensors over a short wiring. It is not suitable for long distances or environments with EMC

interference. We recommend reading Maxim's 1-Wire tips at <http://www.maxim-ic.com/app-notes/index.mvp/id/148>.

The sensors have three wires – positive voltage (+VDD), ground (GND) and bidirectional data (Data). The colors of wires for every sensor are specified in its user manual.

It is strongly recommended to use “daisy-chained” (linear topology) for multiple sensors:

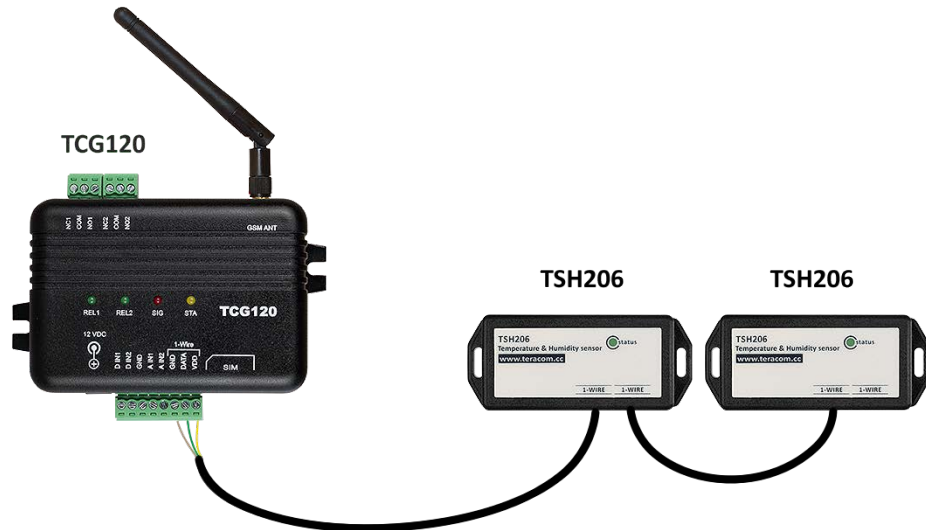

“Star” topology can be used only as a last resort for up to 4 sensors and total cable length up to 10 meters:

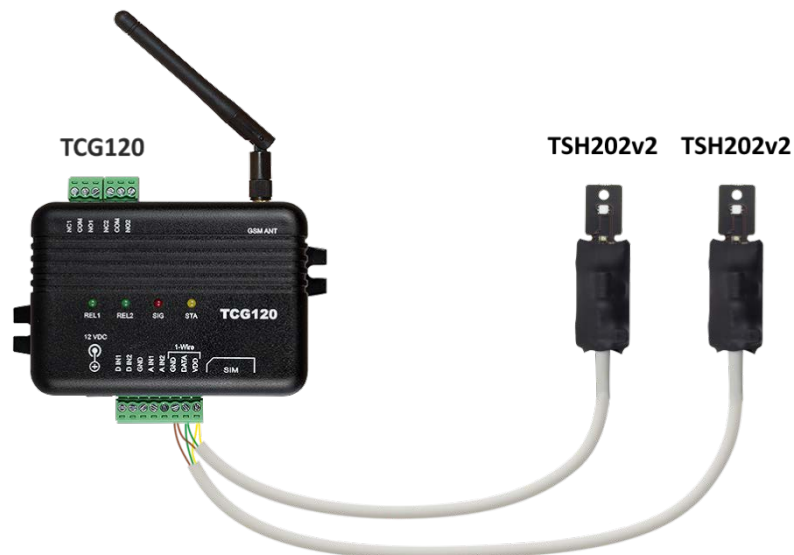

There are many parameters which determine the maximum length of the wires - type of cable, the number of sensors, ambient electromagnetic noise and sensor network topology.

It is strongly recommended to use only UTP/FTP cables and keep total cable length up to 30 m. Although functionality has been achieved in the longer distance, we cannot guarantee error-free operation over mentioned wiring length.

We guarantee proper operation only with Teracom 1-Wire sensors.

5.2.5. Relay connection

The relay contacts are internally connected directly to the terminal connectors. For all relays normally open, normally closed and common contacts are available. For loads with higher switchable current/voltage than specified, an external relay should be used.

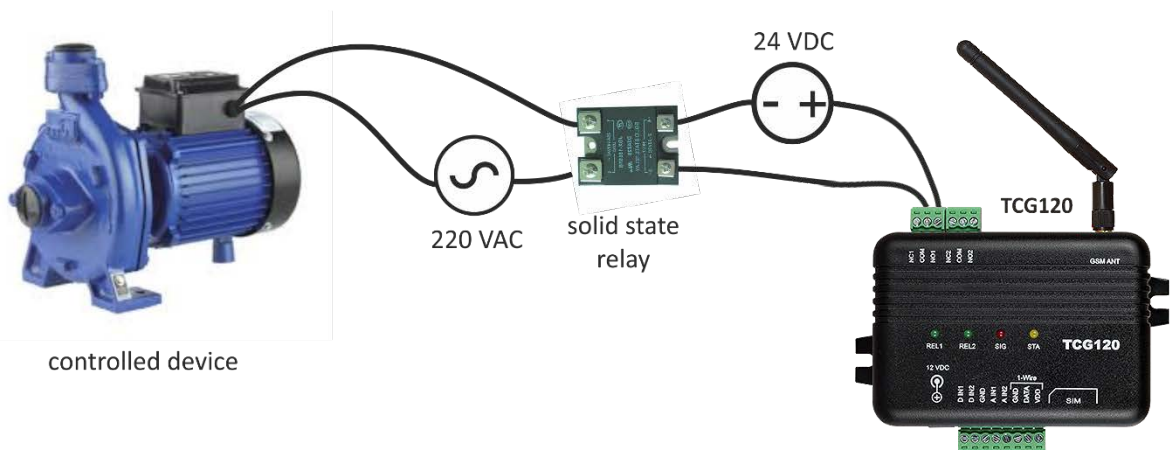

When mechanical relays switch inductive loads such as motors, transformers, relays, etc., the current will arc across the relay contacts each time the contacts open. Over time, this causes wear on the relay contacts which shortens their life. When switching an inductive load, it is recommended that relay contact protection devices are used.

6. LED indicators

LED indicators show the status of the controller:

- **REL1 – REL2 (green)** – the LED is ON when the corresponding relay is activated (the NO contact is connected to COM);
- **SIG (red)** – indicates the status of the device together with STA
- **STA (yellow)** – indicates the status of the device together with SIG.

The following states are displayed:

- **Controller initialization** – after power-on and firmware update SIG and STA turn ON for a second, after this turn OFF for another second.

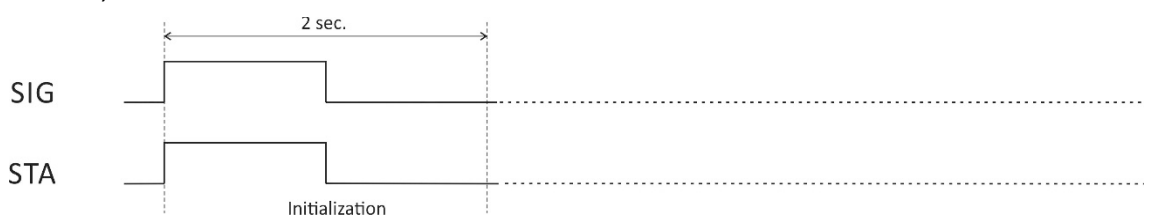

- **Searching for GSM network** – after initialization, SIG is OFF, STA flashes (flash length – 200ms)

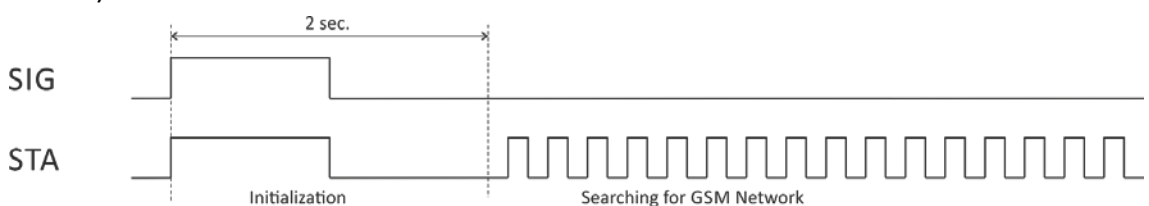

- **Connected to GSM network** – after successful connection to a mobile network, STA shows the type of connection, while SIG shows the signal strength.

STA flashes ones for 200ms in period of 2S – there is GSM connection only;

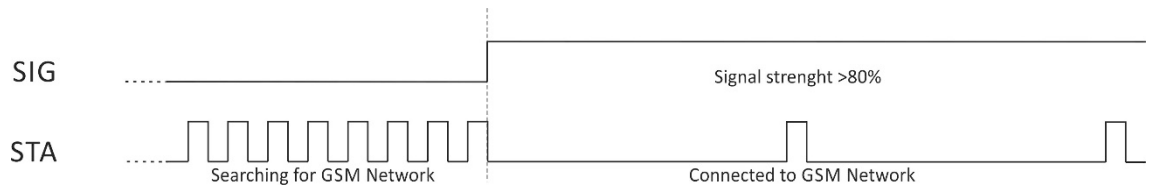

STA flashes twice for 200mS in a period of 2S – there is GSM and GPRS connection.

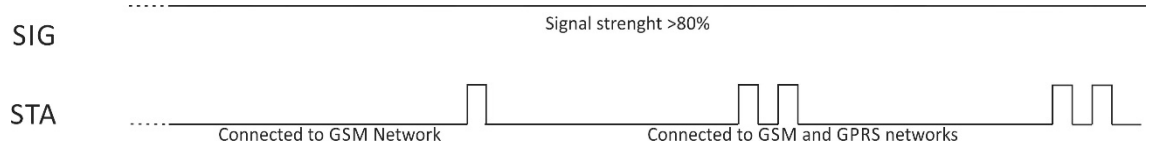

At the same time SIG has 5 states:

- SIG flashes 1 time in period of 2S – signal strength is between 0 and 20%;
- SIG flashes 2 times in period of 2S – signal strength is between 21 and 40%;
- SIG flashes 3 times in period of 2S – signal strength is between 41 and 60%;
- SIG flashes 4 times in period of 2S – signal strength is between 61 and 80%;
- SIG is solid ON – signal strength is between 81 and 100%;

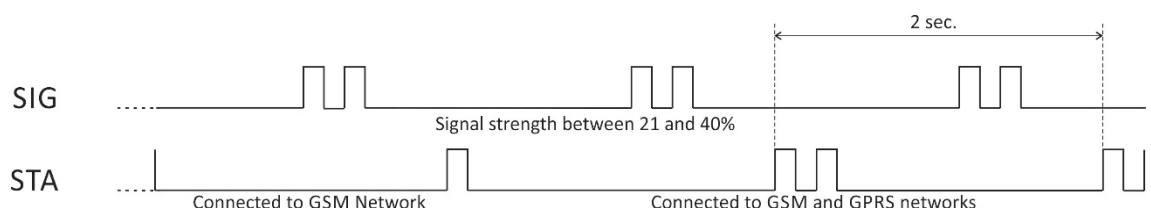
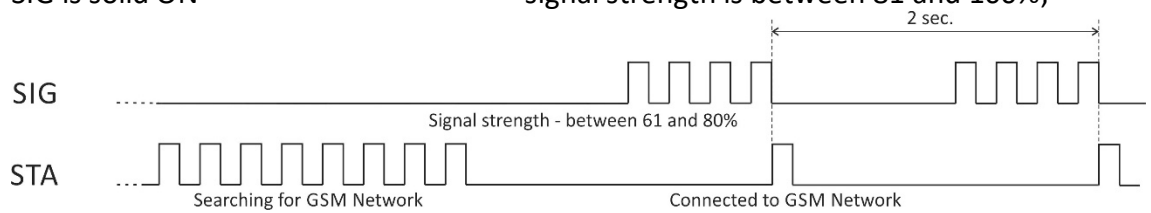

- **Error message** – in case of error after initialization, SIG will stay solid OFF, STA will flash showing the type of error.

- STA flashes ones for 1S – master phone number is not set;
- STA flashes permanently for 1S in a period of 2S – permanent hardware error.

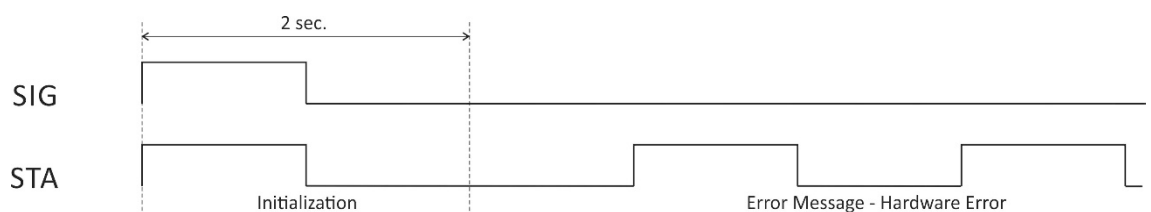
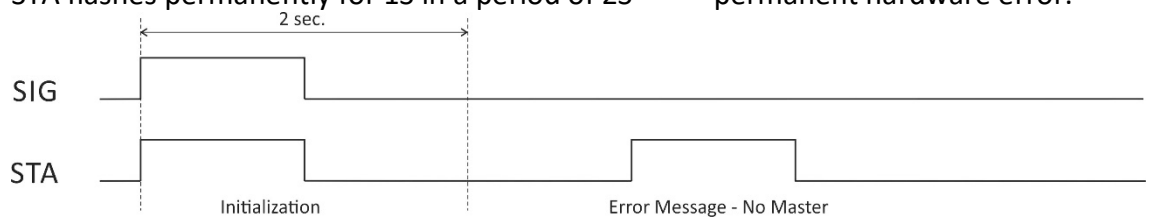

7. Initial setup via USB

The initial setup of TCG120 controller is done with a computer running Windows 7 or newer Microsoft Windows operating system. After power-up, the controller should be connected to the computer with USB cable. Once the USB cable is connected, the operating system automatically starts to install the drivers for the communication with the device. The following message appears:

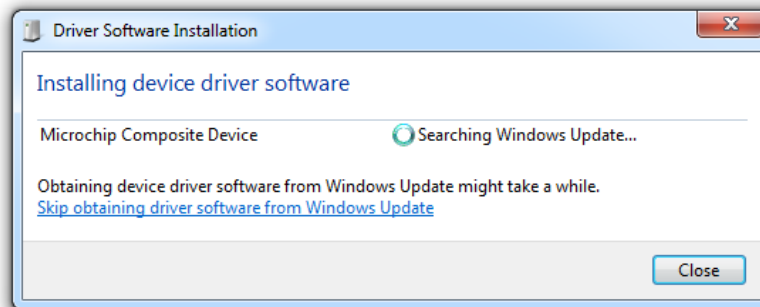

The following drivers will be installed:

- Microchip composite device
- USB serial port driver

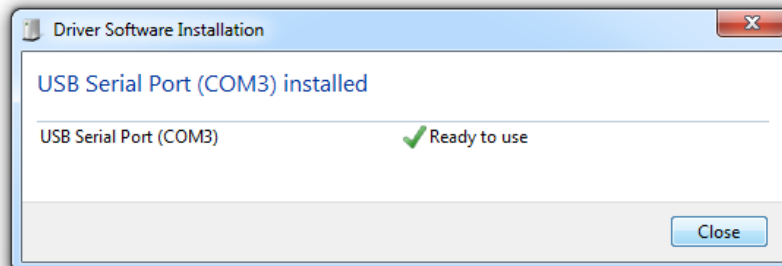

If for some reason the USB serial port driver cannot be installed automatically, it must be installed manually. The driver can be downloaded from the TCG120 product page at www.teracomsystems.com. After successful driver installation, the device will be recognized as Mass storage, the following window appears on the screen:

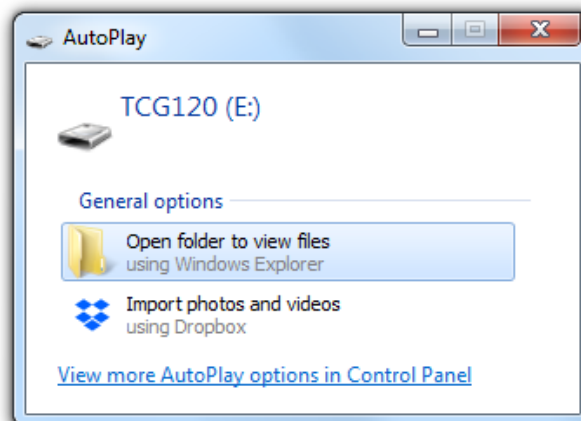

The only file stored on the mass storage is a tool called “TConfig”. This tool enables the communication between the TCG120 and PC. After starting the TConfig tool, the following program will appear:

Pressing the “Start” button will start your web browser and display the Monitoring page of your TCG120 controller.

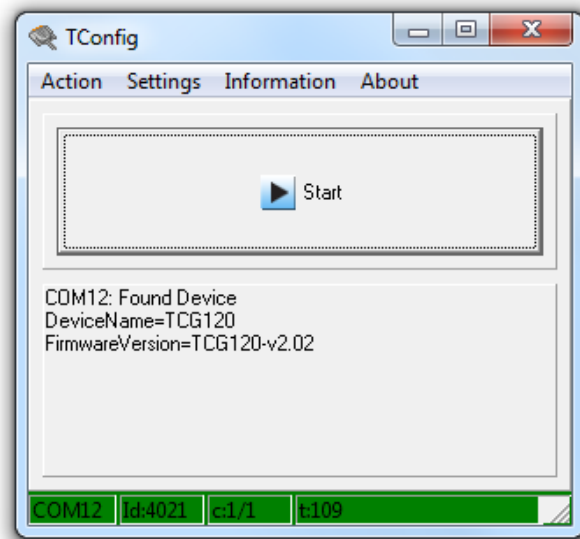

7.1. Monitoring page

Monitoring page displays the current I/O state of TCG120 controller. The page has 4 sections – “Sensors”, “Digital inputs”, “Analog inputs” and “Relays”.

For every parameter (sensor, input, relay) there is a description of up to 20 characters. The default descriptions can be changed in “Setup-Input/Output” menu.

The Monitoring page is automatically refreshed every second.

7.1.1. Sensors section

Pos	Description	Value 1	Value 2	ID	Lock
1	S1:TSH2xx	23.8° C	44.7%RH	015225B71700FF45	<input type="checkbox"/>
2	S2	-----	-----	0000000000000000	<input type="checkbox"/>
3	S3	-----	-----	0000000000000000	<input type="checkbox"/>
4	S4	-----	-----	0000000000000000	<input type="checkbox"/>

Scan for new sensors

All detected 1-Wire sensors are shown in this section. Sensor detection is done either after power-on or by pressing “Scan for new sensors” button. All found sensors are shown in ascending order refer their unique ID number. For every sensor, there are a description, value, and ID information.

Teracom temperature sensors readings are shown in the Value 1 column. TSH2xx temperature-humidity sensors have the 2nd parameter shown on the Value 2 column.

It is possible to lock a sensor on a specific position. To do this all sensors should be added one by one. After every addition, a new scan should be done and newly found sensor should be locked on the position. If all sensors are locked, removing one “in the middle” will not change the positions of following sensors after reset.

7.1.2. Digital inputs section

Digital input	Status	Digital input	Status
Digital In1	OPEN	Digital In2	CLOSED

Digital inputs can be used for monitoring the state of discrete devices – motion sensor, door contact, relay contact, alarm output etc.

Digital inputs are sampled every 10mS. The change of input status is considered valid if the same value is read in 3 consecutive samples (30mS).

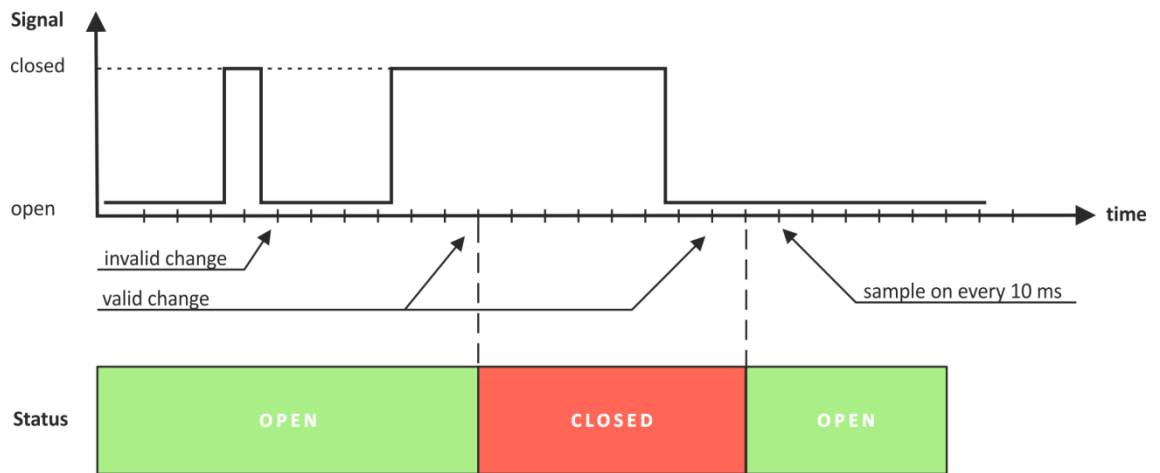

Status of every input is shown by text and by color.

The default descriptions and status names can be changed in “Setup-Input/Output”.

7.1.3. Analog inputs section

Analog input	Value	Analog input	Value
Analog In1	0.001VDC	Analog In2	10.133VDC

Analog inputs can be used for monitoring of DC voltage sources – analog sensors, batteries, power supplies, solar panels etc.

Analog inputs are sampled faster, but the new actual value is changed in 0.5 seconds. All 250 readings between the value changes are averaged.

For every analog input “Unit”, “Multiplier” and “Offset” can be set in “Setup-> Input/Output” section.

7.1.4. Relay section

Relay	Status	Control
Relay1	OFF	controlled by S1:TST1xx Temperature
Relay2	OFF	<input type="button" value="ON"/> <input type="button" value="OFF"/> <input type="button" value="Pulse"/> <input type="button" value="All On"/> <input type="button" value="All Off"/> <input type="button" value="Pulse All"/>

The section displays the current state of the relays. Each relay can be activated either remotely or locally from the status of a monitored parameter. For locally activated relays a text description of the controlling parameter is displayed rather than buttons. It is possible to disable locally control for a while from checkbox “Enable”.

Pulse duration and parameters for local relay activation can be set separately for each relay in “Setup->Input/Output->Relay outputs”. In the time when a pulse command is executed, a new pulse command is rejected.

7.2. Setup

7.2.1. SMS/Call

7.2.1.1. SMS Setup

SMS Setup		Alarm Notification	
Master	<input type="text" value="+359886444735"/>	<input type="checkbox"/>	Phone number format: [+][Country code][Network prefix][Number]
User 1	<input type="text" value="+359882569989"/>	<input checked="" type="checkbox"/>	
User 2	<input type="text"/>	<input type="checkbox"/>	
User 3	<input type="text"/>	<input type="checkbox"/>	
User 4	<input type="text"/>	<input type="checkbox"/>	
<input type="button" value="send test SMS"/>			

SMS Alarm recipients can be set in this section.

The “Master” has special rights to change the device settings using SMS commands. This number always receive the SMS alarm messages.

The remaining 4 recipients can receive SMS messages if any of the parameters is in alarm state. To receive SMS messages, the number should be enabled in the checkbox “Alarm Notification”. These 4 recipients can also ask by SMS for parameter state/value.

By pressing “send test SMS” button all SMS recipients will receive a test SMS.

All commands, their syntax, and answers are described in “Setup via SMS”.

7.2.1.2. Phone call Setup

Phone call setup			
1	+359886000001	2	+359886000002
3	+359886000003	4	+359886000004
5		6	
7		8	
9		10	
11		12	

The relay outputs of TCG120 controller can be controlled (only pulse) by a single call from an authorized number. The maximum number of the authorized numbers is 100. These numbers can be set manually or by sending an SMS message from the Master.

7.2.2. SMTP

7.2.2.1. SMTP Setup

SMTP setup	
Mail server IP/URL	smtp.gmail.com
Mail server port	465
Type of encrypted connection	TLS
Sender e-mail	test@gmail.com
Username	test@gmail.com
Password	*****
<input type="button" value="Test server settings"/>	

Mail server address can be set either by hostname (smtp.gmail.com) or IP address.

The e-mails can be sent with or without an encrypted connection.

The default SMTP port without encryption is 25. Almost all ISP’s block this port to avoid hacker’s attacks. Ask your ISP for details.

The only supported method for encrypted connection from most of the public email servers is TLS. TCG120 supports TLS 1.0, TLS 1.1 and TLS 1.2 with RSA_WITH_AES_128_GCM_SHA256 and RSA_WITH_AES_128_CBC_SHA cipher suites. This ensures successful operation with almost all public servers.

Be careful with the terms SSL, TLS, and STARTTLS used in email server settings, supplied by the provider. Some providers as Gmail uses SSL instead of TLS and TLS instead of STARTTLS. This can provoke mismatches with the port number. The right settings for Gmail for the field “Mail server port” is 465.

Sender e-mail, username, and password are standard authentication details. For the most SMTP servers, sender's e-mail and username are the same.

There is a button for server settings test with a feedback. In this test sender and recipient of the e-mail is the same.

7.2.2.2. Alarm destination

Alarm destinations		
Recipient e-mail	JohnSmith@gmail.com	<input checked="" type="checkbox"/>
Recipient e-mail	test@gmail.com	<input checked="" type="checkbox"/>
Recipient e-mail		<input type="checkbox"/>
Recipient e-mail		<input type="checkbox"/>
Recipient e-mail		<input type="checkbox"/>
<input type="button" value="Test email"/>		

Up to 5 email recipients can be set. Every recipient can be activated independently by a checkbox.

7.2.2.3. Email details

Email details	
Subject	TCG120 Alarm
Body header	From #N, located at #L]
Body	#S,#D=#V#U in #T
Body footer	IMEI:#M
Subject, header and footer variables	Body variables
#N System Name	#D Sensor Description
#L System Location	#V Measured Value
#C System Contact	#U Unit of measured value
#A IP Address of device	#T Time stamp of message
#M IMEI of device	#S Status of parameter-ALARM/NORMAL
#H Hostname	#I ID of message
	#W LoW limit
	#G HiGh limit

The subject, body header, body and body footer can be customized. For this customization, a set of keys is used. All they are described on the page.

7.2.3. Input/Output

7.2.3.1. Sensors

Sensors				
Sensor #	Description	Unit	Multiplier	Offset
S1	S1:TSH2xx	°C	1.000	0.00
		%RH	1.000	0.00
S2	S2	---		

S3	S3	---		

S4	S4	---		

For every sensor, a description, up to 20 symbols can be set. These descriptions will appear on the monitoring page, conditions page, XML/JSON data, SMS and e-mail alerts.

7.2.3.2. Analog inputs

Analog inputs				
Input #	Description	Unit	Multiplier	Offset
AI1	Server room	%RH	31.740	0.826
AI2	Battery	VDC	1.000	0.000

For every analog input, a description, up to 20 symbols can be set. These descriptions will appear on the monitoring page, conditions page, XML/JSON data, SMS and e-mail alerts.

For every analog input, fields “Unit”, “Multiplier” and “Offset” are available to convert the raw voltage/current into meaningful engineering units. The shown value is calculated by:

$$DV[Un] = (AV - OF) * MU$$

Where:

DV – displayed value;

Un – unit;

AV – real analog voltage from source;

MU – multiplier in dimension [parameter/Volt];

OF – offset.

Example:

For humidity sensor HIH-4000-003 following parameter (coming from datasheet) should be set for fine work:

Unit - %RH
 Offset - 0.826
 Multiplier - 31.74, the value is inversed of slope parameter (1/0.0315);

If the output voltage of this sensor is 3.198V on the monitoring page will be shown 75.28% RH:

$$75.28 = (3.198 - 0.826) * 31.74$$

By default and after “Factory default settings” procedure:

Unit - V
 Offset - 0.00
 Multiplier - 1.00

7.2.3.3. Digital inputs

Digital inputs			
Input #	Description	Low level	High level
DI1	<input type="text" value="Digital In1"/>	<input type="text" value="CLOSED"/>	<input type="text" value="OPEN"/>
DI2	<input type="text" value="Digital In2"/>	<input type="text" value="CLOSED"/>	<input type="text" value="OPEN"/>

For every digital input, a description, up to 20 symbols and states up to 20 symbols can be set. These descriptions will appear on the monitoring page, conditions page, XML/JSON data, SMS and e-mail alerts.

7.1.1.2. Relay outputs

Relay outputs				
Relay #	Description	Pulse (seconds)	Activated from	Action on alarm/event
R1	<input type="text" value="Relay 1"/>	<input type="text" value="30.0"/>	<input type="text" value="SMS/HTTP API"/>	<input type="text" value="Single pulse"/>
R2	<input type="text" value="Relay 2"/>	<input type="text" value="2.0"/>	<input type="text" value="SMS/HTTP API"/>	<input type="text" value="Turn on"/>
Relays state after restart		<input type="text" value="Last state"/>		

For every relay description, up to 20 characters can be set. These descriptions will appear on the monitoring page, XML/JSON data, SMS and e-mail alerts.

The pulse duration can be different for both relays. The resolution is 0.1 second, the maximum pulse value is 3600 seconds.

Both relays can be activated either remotely by SMS/single call/HTTP command or locally from the status of a monitored parameter. This setting is made from the “Activated from” drop-down menu, the possible options are:

- **SMS/HTTP** - by selecting this option the relay outputs can be activated by SMS from authorized number or by sending HTTP command (detailed description in “Push mode” section);
- **Phone call** - by selecting this option the relay outputs can be activated (pulse only) by a single call from an authorized number.

For local activation, alarm conditions for different sources are used. They are set up in section “Setup->Conditions”. Following choices to assign a parameter to relay are possible:

- **S?** – “S” stands for “Sensor 1-Wire”. The relay is activated from a value measured from specified 1-Wire sensor and rules for ranges specified in “Setup->Conditions”. Question mark masks number from 1 to 4;
- **Analog input?** The relay is activated from a value measured from specified analog input and rules for ranges specified in “Setup->Conditions”. Question mark masks number from 1 to 2;
- **Digital input?** The relay follows the state of the specified digital input. Question mark masks number from 1 to 2;

The drop-down menu “Action on alarm/event” specifies which action will take place when the alarm/event occurs. Following choices are possible:

- Turn on – the relay will turn on and will remain on until the parameter stays in alarm state;
- Single pulse – the relay will be activated for the set pulse duration.

7.2.4. Conditions

This section is used for parameterization of the trigger and alert conditions for 1-Wire sensors, analog, and digital inputs.

7.2.4.1. 1-Wire sensors and analog inputs

Sensors						If out of range		
#	Description	Type	Min.	Max.	Hys.	mail	sms	post
1	S1:TSH2xx	Temperature, °C	<input type="text" value="-40.0"/>	<input type="text" value="85.0"/>	<input type="text" value="8.5"/>	<input type="checkbox"/>	<input type="checkbox"/>	<input type="checkbox"/>
		Humidity, %RH	<input type="text" value="0.0"/>	<input type="text" value="100.0"/>	<input type="text" value="10.0"/>	<input type="checkbox"/>	<input type="checkbox"/>	<input type="checkbox"/>
2	S2	---	<input type="text" value="---"/>	<input type="text" value="---"/>	<input type="text" value="---"/>	<input type="checkbox"/>	<input type="checkbox"/>	<input type="checkbox"/>
		---	<input type="text" value="---"/>	<input type="text" value="---"/>	<input type="text" value="---"/>	<input type="checkbox"/>	<input type="checkbox"/>	<input type="checkbox"/>
3	S3	---	<input type="text" value="---"/>	<input type="text" value="---"/>	<input type="text" value="---"/>	<input type="checkbox"/>	<input type="checkbox"/>	<input type="checkbox"/>
		---	<input type="text" value="---"/>	<input type="text" value="---"/>	<input type="text" value="---"/>	<input type="checkbox"/>	<input type="checkbox"/>	<input type="checkbox"/>
4	S4	---	<input type="text" value="---"/>	<input type="text" value="---"/>	<input type="text" value="---"/>	<input type="checkbox"/>	<input type="checkbox"/>	<input type="checkbox"/>
		---	<input type="text" value="---"/>	<input type="text" value="---"/>	<input type="text" value="---"/>	<input type="checkbox"/>	<input type="checkbox"/>	<input type="checkbox"/>
Return notification		<input type="checkbox"/>	Notification delay (seconds)			<input type="text" value="0"/>	(0-3600)	

Analog inputs						If out of range		
#	Description	Dimension	Min.	Max.	Hys.	mail	sms	post
1	Analog In1	VDC	<input type="text" value="0.000"/>	<input type="text" value="60.000"/>	<input type="text" value="0.100"/>	<input type="checkbox"/>	<input type="checkbox"/>	<input type="checkbox"/>
2	Analog In2	VDC	<input type="text" value="0.000"/>	<input type="text" value="60.000"/>	<input type="text" value="0.100"/>	<input type="checkbox"/>	<input type="checkbox"/>	<input type="checkbox"/>
Return notification		<input type="checkbox"/>	Notification delay (seconds)			<input type="text" value="0"/>	(0-3600)	

For every sensor two type of fields are presented – one for the trigger conditions (“Min”, “Max” and “Hys.”) and another one for the wanted action.

“Min” and “Max” indicate the border of working range for the monitored parameter. A “Max” trigger condition occurs when the value exceeds the trigger set point. A “Min” trigger condition occurs when the value is lower than the trigger set point. In both cases, the monitored parameter goes out of range.

Coming back in range for the monitored parameter is considered when the value goes higher than (Min + Hys) or lower than (Max – Hys). Hysteresis (“Hys”) is used to prevent excessively triggering when the value fluctuates around the trigger point.

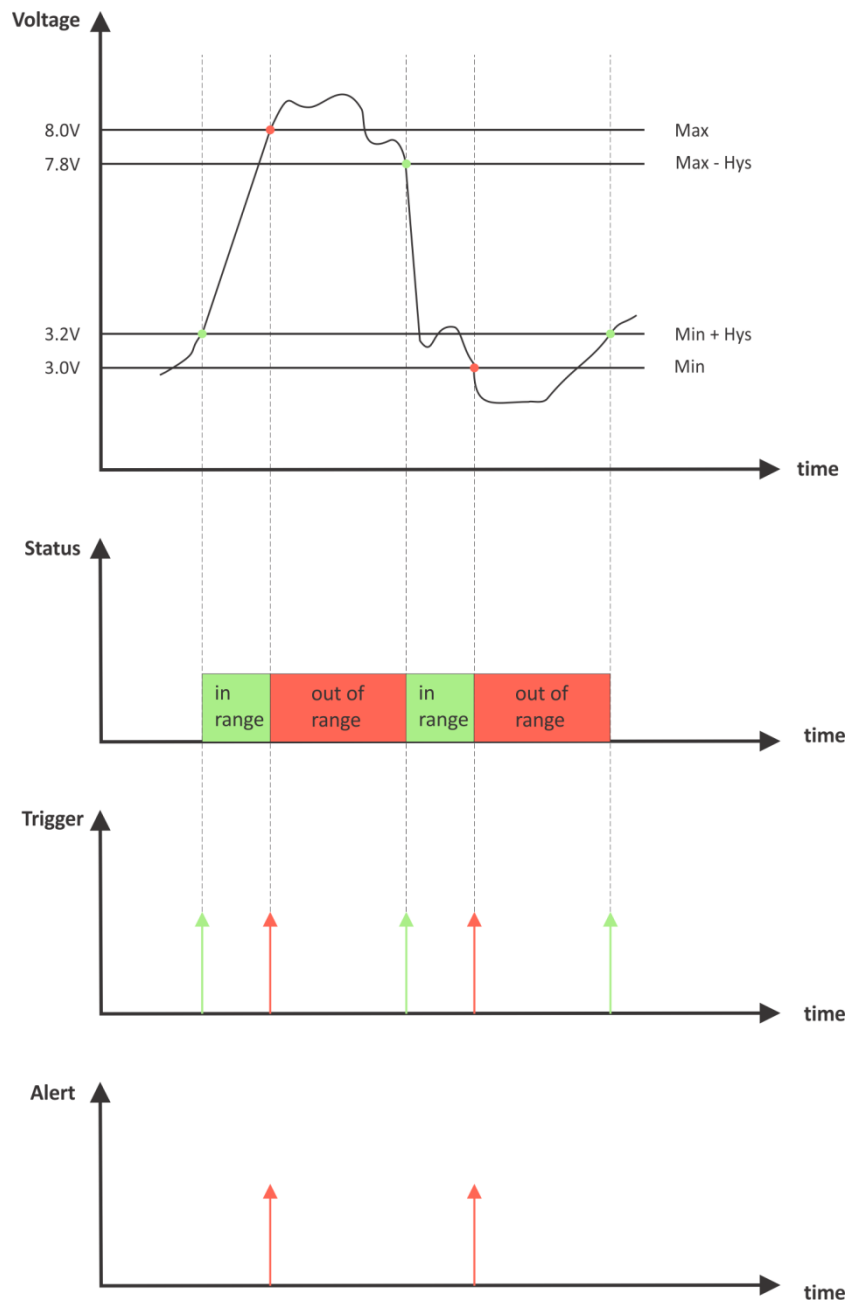

Example:

TCG120, TST100, and appropriate heater are used to control the room temperature. The wanted minimum temperature is 19°C. The initial temperature is 17°C.

TST100 is assigned to the first position for 1-Wire sensors.

For Relay1 local activation from Sensor1 is set.

Following parameters are set for Sensor1: Min=19, Max=100 and Hys=0.5.

Sensors						If out of range		
#	Description	Type	Min.	Max.	Hys.	mail	sms	post
1	S1:TST1xx	Temperature, °C	19.0	100.0	0.5	<input checked="" type="checkbox"/>	<input type="checkbox"/>	<input type="checkbox"/>

When the controller is switched on, Relay1 is immediately activated because the monitored temperature is out of range. This switches the heater on. The temperature rises.

When the temperature reaches 19.5°C (19.0 + 0.5) it goes in range (trigger condition) and Relay1 is deactivated. The heater is switched off.

The temperature falls and when it reached 19°C it goes out of range (trigger and alert conditions). The relay is activated (heater is switched on) and e-mail is sent.

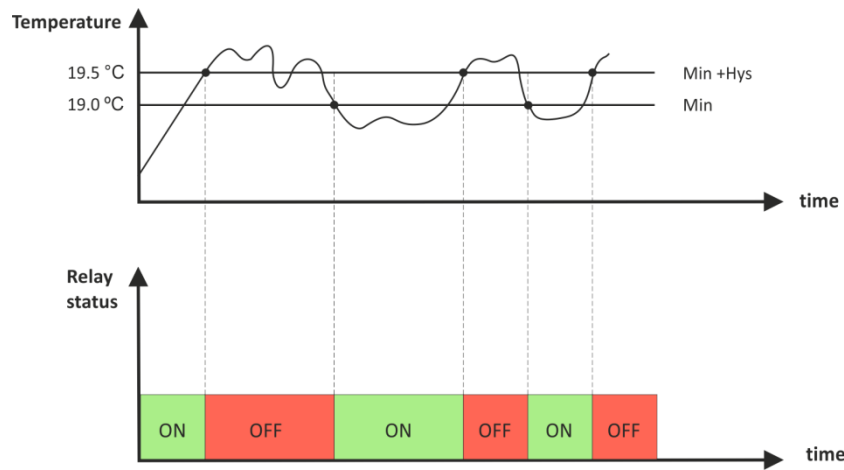

The “Max” value is set far enough from the wanted temperature to avoid trigger/alert conditions around it.

For every sensor or analog input, there are 3 independent ways of alert when there is an alarm condition – email, SMS, and post (HTTP post with XML/JSON file). Each alarm notification method is activated by a checkbox.

Globally for all sensors and for all analog inputs, there is a checkbox “Return notification”. If this option is chosen there will be notification also when parameter returns in range.

Globally for all sensors and for all analog inputs, there is a “Notification delay” parameter. It is very useful like a filter for short alarm conditions.

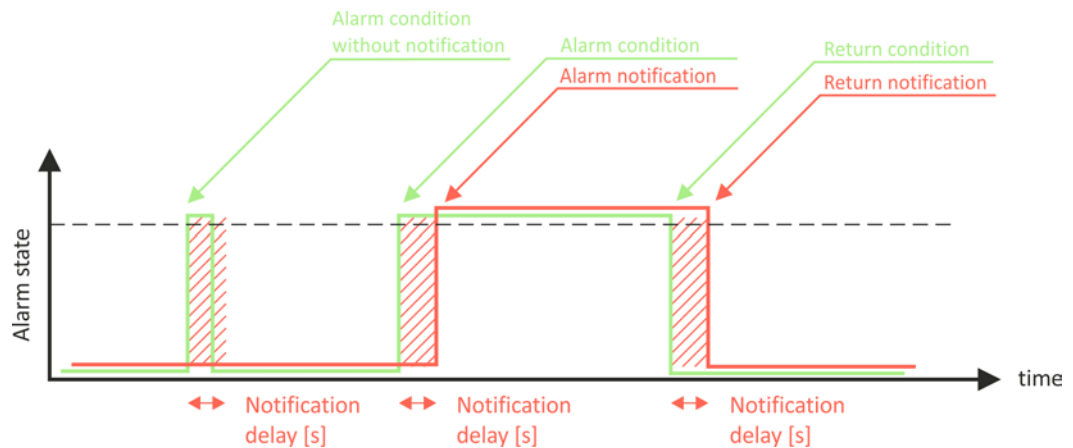

7.2.4.2. Digital inputs

Digital inputs						On active alarm		
#	Description	Current state	Select alarm state	Low to high delay	High to low delay	mail	sms	post
1	Door	OPEN	CLOSED ▾	0.0 (0-3600)	0.0 (0-3600)	<input type="checkbox"/>	<input type="checkbox"/>	<input type="checkbox"/>
2	Tank	Full	Empty ▾	0.0 (0-3600)	0.0 (0-3600)	<input type="checkbox"/>	<input checked="" type="checkbox"/>	<input type="checkbox"/>
Return notification		<input checked="" type="checkbox"/>	Notification delay (seconds)		0 (0-3600)			

For every digital input, the alarm state should be chosen – Open or Close.

When the input goes in alarm state 3 independent alert actions are possible – email, SMS, and post (HTTP post with XML/JSON file). Each alarm notification method is activated by a checkbox.

Globally for all digital inputs, there is a checkbox “Return notification”. If this option is chosen there will be notification also when parameter returns in range.

Globally for all digital inputs, there is a “Notification delay” parameter. It is very useful like a filter for short alarm conditions.

In the time when the input is in an alarm state, on „Monitoring page“, the appropriate input will be colored in red.

There are two delays - low-to-high and high-to-low for digital input change. These delays are added to the standard delay of 30ms. They have 0.1-second resolution and by default are zero. These options can be used for additional filtering.

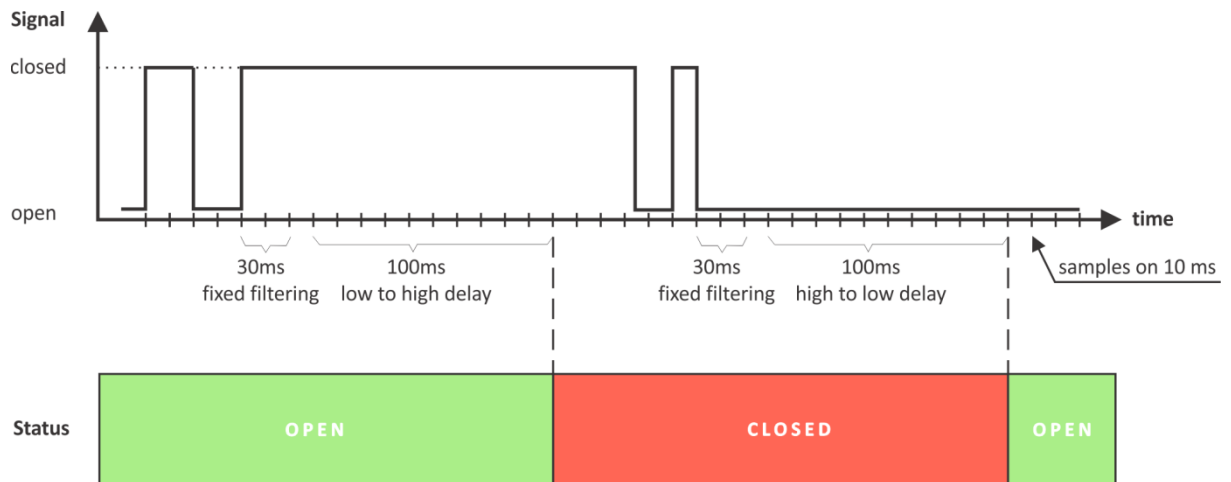

7.2.5. System

The page for some general settings.

7.2.5.1. System status

System status			
GSM connection	Yes	Data in roaming	<input type="checkbox"/>
GPRS connection	Yes	GPRS in roaming	No
Signal strength	-63dBm(80%)	Service	1
Service provider	Mobitel EAD	IP address	10.51.75.167
Mobile Country Code(MCC)	284	Location Area Code(LAC)	28200
Mobile Network Code(MNC)	01	Cell ID(CID)	38449
IMEI	863071015406348	GSM FW version	M95EBR01A06

There is information about the general status of the controller here.

The only possible setting here is “Data in roaming” checkbox. By default, it is disabled to avoid extra charges for data transfer in roaming.

If you are using another operator's card, you must activate “Data in roaming”. Otherwise, you will not be able to use all GPRS services – emails, HTTP Post, NTP, etc.

7.2.5.2. GPRS setup

GPRS Setup	
APN	<input type="text" value="internet"/>
Username	<input type="text"/>
Password	<input type="text"/>

To set the GPRS connection it is necessary to enter the APN (Access Point Name). This setting can be different for each GSM service provider. By default, it is set to “internet”. Some providers may require also username and password.

7.2.5.3. Mobile network connection reset

For areas with low signal strength or where the mobile network frequently drop/block, automatic restarting of the network connection can be used. This could prevent permanently losing the connection with the device.

The automatic restart will be done once per day.

By default, the automatic restart is disabled.

Mobile network connection reset	
Automatic network connection reset	<input type="text" value="Disable"/>
Time of the reset(hh:mm:ss)	<input type="text" value="00:00:00"/>

7.2.5.4. General setup

General setup			
Temperature units	<input type="text" value="Celsius"/>	Sensors	<input checked="" type="checkbox"/>
Pressure units	<input type="text" value="hPa"/>	Analog inputs	<input checked="" type="checkbox"/>
Host name	<input type="text" value="TCG120"/>	Digital inputs	<input checked="" type="checkbox"/>
Writing mode	<input type="text" value="left-to-right"/>	Relay outputs	<input checked="" type="checkbox"/>
System name	<input type="text" value="TCG120"/>		
System location	<input type="text" value="Location"/>		
System contact	<input type="text" value="info@teracomsystems.com"/>		

The section for some general settings.

The temperature and pressure units can be changed with preferable ones.

Writing mode change the alignment in the WEB interface and SMS.

Hostname, System name, System location, and System contact are sent in XML/JSON files and can be used for flexible identification of the device. These parameters can be also included in the body of the e-mails.

The checkboxes on the right define what to be displayed on the “Monitoring page”. By default, they all are enabled.

7.2.5.5. Device restart

In this section there are tools for full device restart and reset to factory default settings.

Device restart	
<input type="button" value="Reset to default"/>	<input type="button" value="Device restart"/>

7.2.6. Time

Time setup	
NTP server IP/URL	<input type="text" value="time.google.com:123"/>
Time zone	<input type="text" value="+02:00"/>
Interval (h)	<input type="text" value="12"/>
If not found (h)	<input type="text" value="1"/>

Uptime	
Uptime	0days,00:00:28

Current time	09.03.2018,10:35:37
Last updated	09.03.2018,10:35:36
Status	OK

Internal RTC (real-time clock) of the controller can be set either manually or automatically.

For automatic clock synchronization, the controller supports NTP (Network Time Protocol) and all necessary parameters for automatic synchronization are available in this section.

The clock synchronization is made on “Interval” time. If the attempt was not successful, the next synchronization will be on “If not found” time.

Pressing the “Save and synchronize” button initiates time synchronization. The information for “Status” in the blue box is very useful for the availability of time server and Internet at all.

The current system time is sent in XML/JSON file when HTTP Post is enabled

By default, NTP server – time.google.com, port - 123, Timezone +00:00 and interval of 12 hours.

7.3. Services

7.3.1. HTTP Post

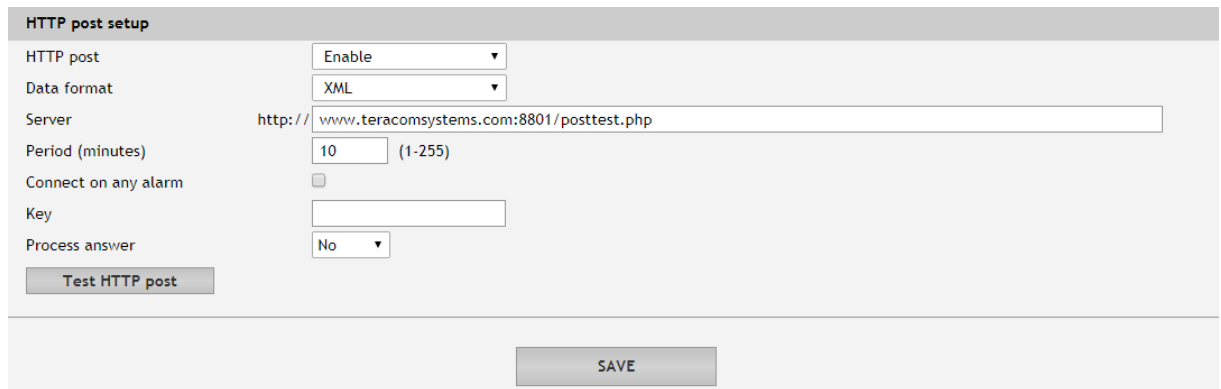

The screenshot shows a web-based configuration form titled "HTTP post setup". The form contains the following fields and controls:

- HTTP post:** A dropdown menu set to "Enable".
- Data format:** A dropdown menu set to "XML".
- Server:** A text input field containing "http://www.teracomsystems.com:8801/posttest.php".
- Period (minutes):** A text input field containing "10", with "(1-255)" displayed next to it.
- Connect on any alarm:** An unchecked checkbox.
- Key:** An empty text input field.
- Process answer:** A dropdown menu set to "No".

At the bottom left of the form is a button labeled "Test HTTP post". At the bottom center, below the form, is a "SAVE" button.

HTTP Post is used for periodically upload an XML/JSON file to HTTP server by HTTP requests (POST method). The XML/JSON file contains current status of all monitored parameters and extra system information. The file format is chosen from the drop-down menu.

The HTTP server can be addressed either by domain name or IP address.

The "Period" can be set between 1 and 255 minutes. This parameter can be changed remotely also by HTTP API. The "Period" determines at what time the control software receives up-to-date information from TCG120 and can, therefore, make changes to some of the parameters. The shorter is "Period", the closer to the real-time operation is the system. On the other hand, as shorter is the "Period" as higher is the data traffic through the mobile network.

If the checkbox "Connect on any alarm" is selected, the HTTP Post request will be sent in an alarm condition.

The "Key" field is user defined. Its value is sent in XML/JSON file and can be used for device identification.

If "Process Answer" option is enabled, TCG120 will execute the commands, sent by the remote server as an answer to HTTP Post.

A typical communication session between TCG120 and remote server is shown below:

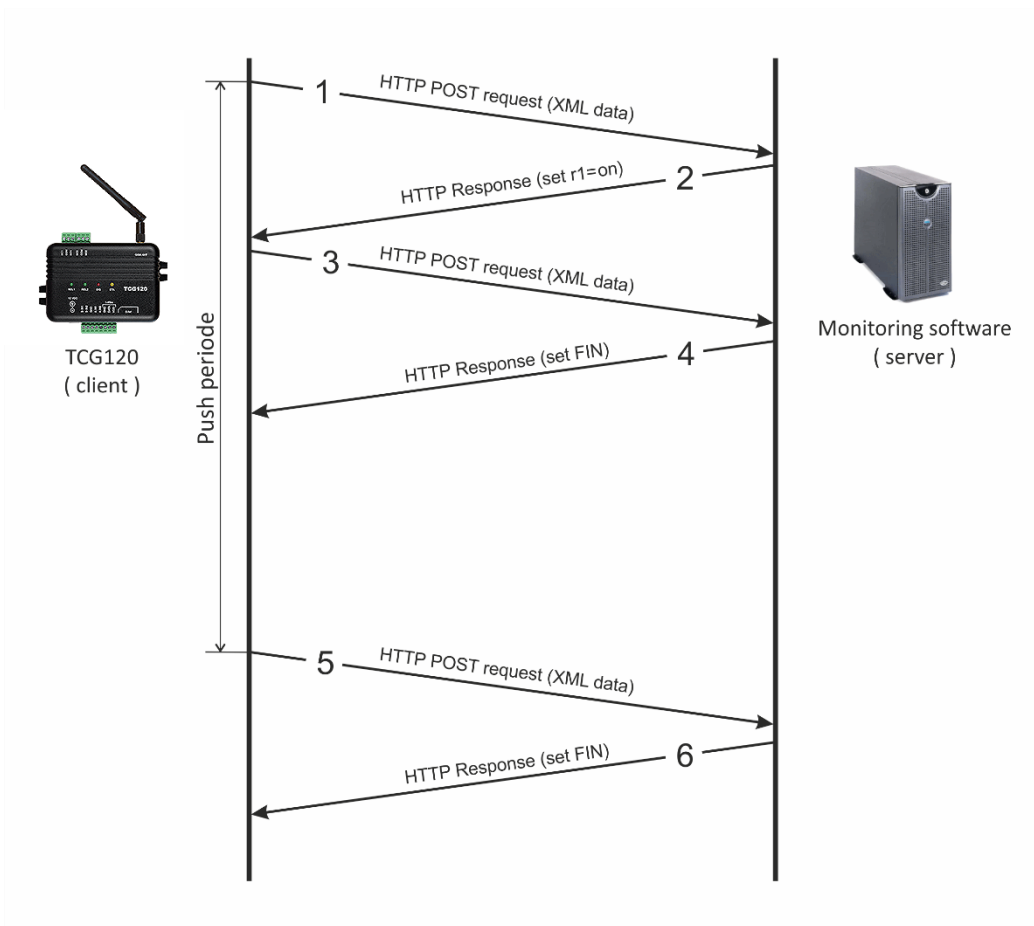

Step 1 - HTTP POST request with XML data is sent to the remote server

Step 2 - the server responds with HTTP response message, which contains “set r1=on” command as a brief text in the message body

Step 3 - new HTTP POST request is sent to the server to confirm the reception of the “set r1=on” command.

Step 4 - the server sends new HTTP response, which includes “set FIN” in the message body. This indicates that there are no pending commands and the session can be closed.

Step 5 - when the Push period timer expires, TCG120 sends new HTTP POST request to the server

Step 6 – the server answers with “set FIN” – there is no pending commands and the session can be closed.

HTTP Post command format:

set yyy=xxx

Where:

yyy is the command;

xxx is the parameter.

List of HTTP API commands:

Command	Description
r <i>n</i> = <i>x</i>	Turn relay n ON (<i>x</i> =1) or OFF (<i>x</i> =0) (n is 1 or 2 for the respective relay) r1=1 - will turn ON relay 1 r2=0 – will turn OFF relay 2
r1=1&r2=1	Turn both relays ON
r1=0&r2=0	Turn both relays OFF

rn= tg	Toggle relay n (n is 1 or 2 for the respective relay) r2= tg – will toggle relay 2
rn= pl	Pulse relay n (n is 1 or 2 for the respective relay) r2=pl – will pulse relay 2 *
vnf= 10.0	Set Min of analog input to 10.0 (f is 1 or 2 for the respective input) vn1=10.0 will set Min for analog input 1
vxf= 20.0	Set Max of analog input to 20.0 (f is 1 or 2 for the respective input) vx2=20.0 will set Max for analog input 2
vyf= 1.0	Set Hys of analog input to 1.0 (f is 1 or 2 for the respective input) vy1=1.0 will set Hys for analog input 1
snpt= 30.0	Set Min of sensor to 30.0 (p is 1,2,3 or 4 for the respective sensor t is 1 or 2 for the respective parameter of sensor) sn12=30.0 will set Min for sensor 1, parameter 2
sxpt= 40.0	Set Max of sensor to 40.0 (p is 1,2,3 or 4 for the respective sensor t is 1 or 2 for the respective parameter of sensor) sx42=40.0 will set Max for sensor 4, parameter 2
sypt= 2.0	Set Hys of sensor to 2.0 (p is 1,2,3 or 4 for the respective sensor t is 1 or 2 for the respective parameter of sensor) sy41=2.0 will set Hys for sensor 4, parameter 1
delsen= xxxx	Notification delay for sensors (xxxx is between 0 and 3600)
delanl= xxxx	Notification delay for analog inputs (xxxx is between 0 and 3600)
deldig= xxxx	Notification delay for digital inputs (xxxx is between 0 and 3600)
dda1= xxxx	Low to high delay for digital input 1 (xxxx is between 0 and 3600)
ddd1= xxxx	High to low delay for digital input 1 (xxxx is between 0 and 3600)
dda2= xxxx	Low to high delay for digital input 2 (xxxx is between 0 and 3600)
ddd2= xxxx	High to low delay for digital input 2 (xxxx is between 0 and 3600)

pmet=x	Enable/disable HTTP Post - 0 disable, 2 enable
dataf=x	Data format XML/JSON for HHTTP Post – 0 XML, 1 JSON
purl=yyy	URL for HTTP Post to Server 1, where yyy is a full path to php file Example: purl=212.25.45.120:30181/xampp/test/pushtest.php
pper=xxx	HTTP Post period in minutes (xxx is between 1 and 255)
dk=xxx	HTTP Post key – xxx is up to 17 characters
pans=x	HTTP Post process answer – 0 No, 1 Yes
FIN	Terminate session (it makes sense only for HTTP Post)

*In the time when a pulse command is executed, any new pulse command is rejected.

The typical monitoring application is shown in the picture below:

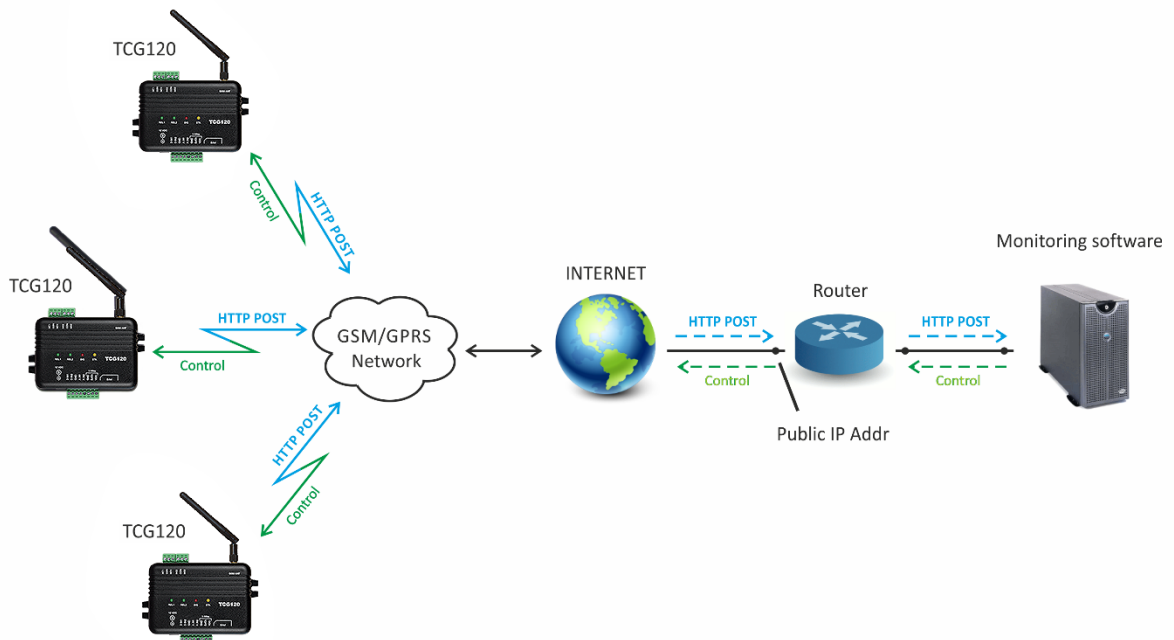

The structure of Status.xml is shown in Appendix A, while Status.json is shown in Appendix B.

7.4. Administration

7.4.1. Backup/Restore

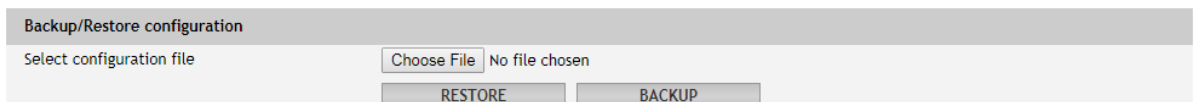

TCG120 supports backup and restore of all user setting. All settings are saved in XML backup file. This file can be used after this for restore on many devices. This is very useful for multiplying similar settings to a batch of controllers

7.4.2. Firmware update

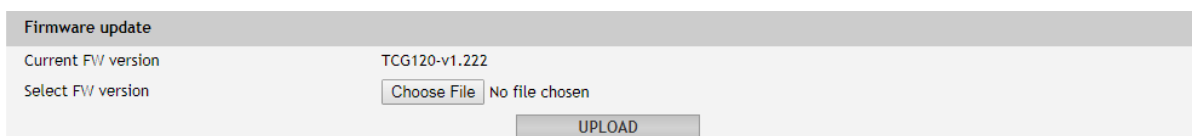

TCG120 supports firmware update over the WEB interface.

It is very simple. Download the latest firmware from www.teracomsystems.com, choose the file and press “upload” button.

Attention! Don't turn off the power supply during the update. Turning off the power supply will damage the device.

8. Setup via SMS

TCG120 supports SMS commands for parameters change and status reports, including firmware update over the air. The commands will be executed if they are sent from previous set 5 phone number. Some of the commands require Master user rights.

Below is a list of the supported SMS commands. Note that the underscore character “_” must be replaced by one space character.

- **Set new master number**

Rights: Master
Syntax: set_master_<number>
Where
<number> is a mobile number in the international format

Example

Command: set master +359885885885

Answer: You are the new master!

- **Set SMS users numbers** - this message is used to add/delete SMS users

Rights: Master
Syntax: set_sms_user_<user>:<number>
Where
<number> is a mobile number in the international format
<user> can be u1, u2, u3 or u4

Example

Command: set sms user u1:+359885887766

Answer: u1:+359885887766,u2,u3,u4

Command: set sms user u2:+359885999888

Answer: u1:+359885887766, u2:+359885999888,u3,u4

Command: set sms user u1:

Answer: u1, u2:+359885999888,u3,u4

- **Display SMS users numbers**

Rights: Master, Users
Syntax: display_sms_users

Example

Command: display sms users

Answer: m:+359885885885,u1:+359885887766,u2:+359885999888,u3,u4

- **Set email users** - this message is used to add/delete email users

Rights: Master
Syntax: set_email_user_<user>:<email>
Where
<email> - a valid email address
<user> can be e1, e2, e3, e4 or e5

Example

Command: set email user e1:mail1@teracomsystems.com

Answer: e1:mail1@teracomsystems.com

Command: set email user e2:mail2@teracomsystems.com

Answer: e2:mail2@teracomsystems.com

Command: set email user e2:

Answer: e2:

- **Display email users** - this message is used to request the email of a user

Rights: Master, Users

Syntax: display_email_<user>

Where

<user> can be one of: e1, e2, e3, e4 or e5

Example

Command: display email e1

Answer: e1:mail1@teracomsystems.com

Command: display email e2

Answer: e2:mail2@teracomsystems.com

- **Add call users** - this message is used to add/delete call users

Rights: Master

Syntax: add_call_user_<number>

Where

<number> is a mobile number in the international format

Example

Command: add call user +359885111111

Answer: +359885111111 added

- **Display call users** - this message is used to request a list of call users

Rights: Master, Users

Syntax: display_call_users_<U>

Where

<U> - number from 1 to 10

If U=1, the answer will contain the numbers from 1 to 10. If U=5, the answer will contain the numbers from position 41 to 50 etc.

Example

Command: display call users 3

*Answer: +359885122112+359885322343+359885431276+359885128734
+35988343434 +359885239854+359885233298+359885120954
+359885098765+35988345678*

- **Remove call user** - this message is used to delete call users

Rights: Master

Syntax: remove_call_user_<number>

Where

<number> is mobile numbers in the international format

Example

Command: remove call user +359885111111

Answer: +359885111111 removed

- **Status of system** - requests main parameters of the device

Rights: Master, Users

Syntax: status_system

Example

Command: status system

Answer: 01.03.2018,16:09:06,gprs=y,ss=80%,fw=2.02,call=2/100

- **Status of parameter** - requests status of digital input (di), analog input (ai), relay (r) and sensor(s)

Rights: Master, Users

Syntax: status_<param>
Where
<param> is one of: di1, di2, ai1, ai2, r1, r2, s11, s12, s21, s22, s31, s32, s41, s42

Example

Command: status di1
Answer: di1(Garage_door)=CLOSED
Command: status s22
Answer: s22(Office)=34.5%RH

- **Set a relay** - this message is used to switch on/off the selected relay output

Rights: Master, Users
Syntax: set_<relay>=<state>_[option]
Where
<relay> is r1, r2
<state> is 1, 0
[option] -w

Example

Command: set r1=1
Answer: r1=on,r2=off
Command: set r1=0
Answer: r1=off,r2=off
Command: set r1=1 -w
Answer: no answer
Command: set r1=0 -w
Answer: no answer

- **Set pulse for a relay** - this message is used to pulse the selected relay output

Rights: Master, Users
Syntax: set_<pulse relay>=<state>_[option]
Where
< pulse relay > is pl1, pl2
<state> is 1
[option] -w

Example

Command: set pl1=1
Answer: r1=on,r2=off
Command: set pl2=1
Answer: r1=off,r2=on
Command: set pl1=1 -w
Answer: no answer
Note: In the time when a pulse command is executed, a new pulse command is rejected

- **Post URL** – sets URL for HTTP Post

Rights: Master
Syntax: set_purl=<link>
Where
<link> is the address of remote server (domain or IP)

Example

Command: set purl=www.teracomsystems.com:8801/posttest.php

Answer: `post=off,period=5,url=www.teracomsystems.com:8801/posttest.php`

- **Status URL** – status URL's for HTTP Post

Rights: Master, User
Syntax: `status_purl`

Example

Command: `status purl`

Answer: `purl=www.teracomsystems.com:8801/posttest.php,post=on,period=5`

- **Post period** – sets HTTP Post period

Rights: Master
Syntax: `set_pper=<value>`
Where
<value> is a number between 1 and 255 (minutes)

Example

Command: `set pper=10`

Answer: `post=off,period=10,url=www.teracomsystems.com:8801/posttest.php`

- **Post on** – sets HTTP Post on

Rights: Master
Syntax: `set_post=on`

Example

Command: `set post=on`

Answer: `post=on,period=10,url=www.teracomsystems.com:8801/posttest.php`

- **Post off** – sets HTTP Post off

Rights: Master
Syntax: `set_post=off`

Example

Command: `set post=off`

Answer: `post=off,period=10,url=www.teracomsystems.com:8801/posttest.php`

- **Set a time server**

Rights: Master
Syntax: `set_ts=url:port`

Example

Command: `set ts=time.google.com:123`

Answer: `ts=time.google.com:123,tz=+02:00`

- **Set a time zone**

Rights: Master
Syntax: `set_tz=±hh:mm`

Example

Command: `set tz=+03:00`

Answer: `ts=time.google.com:123,tz=+03:00`

- **Set the hostname**

Rights: Master
Syntax: `set hostname=host_name`

Example

Command: set hostname=teracomsystems

Answer: hostname=teracomsystems

- **Restart** – restarts the device

Rights: Master

Syntax: restart

Example

Command: restart

Answer: Device is restarting!

- **Send test email** – a message for sending a test email to the email users

Rights: Master

Syntax: test_email

Example

Command: test email

Answer: Emails are sending!

- **Send test SMS** – a message for sending a test SMS to the authorized users

Rights: Master

Syntax: test_sms

Example

Command: test sms

Answer: This is a test SMS!

- **Update** – a message for update the device over the air (GPRS)

Rights: Master

Syntax: update_<URL>

Where

<URL> is a valid URL to public server, pointing update (.cod) file

Example

Command: update www.teracomsystems.com/docs/TCG120-v2.02-P-S.cod

Answer 1: Downloading firmware...

Answer 2: Firmware file downloaded. Updating...

Following answers are also possible in different situations:

Answer: File corrupt or wrong version!

Answer: Can't connect to server!

Answer: Download time out!

Answer: GPRS is not connected!

Answer: Connection lost!

Answer: Response timeout!

Answer: Socket error!

9. Firmware update

TCG120 supports firmware update over the WEB interface and over the air.

For firmware update over the WEB interface please see 7.4.2. FW update.

For firmware update over the air (GPRS) please follow the steps below:

- Upload the update file (.cod extension) on public HTTP server ;
- Send firmware update command (the syntax of the SMS message is described in 8. Setup via SMS).

Please note that only the Master can send this message.

The firmware will be downloaded and verified. The download via GPRS takes around 3 minutes. If the file is correct, the Master will receive confirmation SMS message. The update procedure takes around 2 minutes. Once the firmware update is complete (about 5 minutes), TCG120 will restart.

Attention! Don't turn off the power supply during the update. Turning off the power supply will damage the device.

10. Factory default settings

TCG120 can be restored to its original factory default settings, following the steps below:

- Turn off the power supply;
- Press and hold the RESET button then turn on the power supply;
- STA and SIG LEDs will turn ON;
- Release the RESET button.

The controller will restore its default settings.

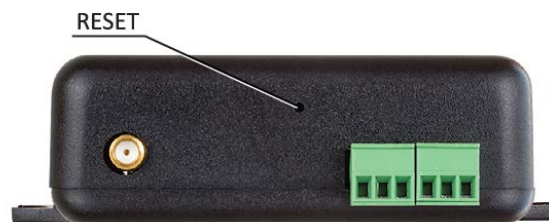

11. Environment information

This equipment is intended for use in a Pollution Degree 2 environment, at altitudes up to 2000 meters. When the controller is a part of a system, the other elements of the system shall comply with the EMC requirements and shall be intended for use in the same ambient conditions.

12. Safety

This device must not be used for medical, life-saving purposes or for any purpose where its failure could cause serious injury or the loss of life.

To reduce the risk of fire, only flexible stranded wire, with cross section 0.5mm² or larger for wiring of digital and analog inputs and relay output of the device should be used.

To avoid electric shock and fire hazard, do not expose this product to liquids, rain, or moisture. Objects filled with liquids, such as vases, should not be placed on this device.

There is a risk of overheating (damage) of the controller, if recommended free spaces to adjacent devices are not ensured. The joint part with external component shall have space for attachment/removal of the cable after installation.

Teracom does not guarantee successful operation of the product if the product was used under conditions deviating from the product specifications.

13. Maintenance

Upon completion of any service or repairs to the device or once per year, safety check must be performed to determine that this product is in proper operating condition. Clean the device only with dry cloth. Do not use a liquid cleaner or an aerosol cleaner. Do not use a magnetic/static cleaning device (dust remover) or any kind of abrasive materials to clean the device.

14. Package content

1. TCG120
2. GSM antenna
3. Quick start guide

Appendix A

Structure of Status.xml file:

```
<Monitor>
  <DeviceInfo>
    <DeviceName>TCG120</DeviceName>
    <HostName>TCG120</HostName>
    <ID>863071015406348</ID>
    <FwVer>v2.08</FwVer>
    <MnfInfo>www.teracomsystems.com</MnfInfo>
    <SysContact>info@teracomsystems.com</SysContact>
    <SysName>TCG120</SysName>
    <SysLocation>Location</SysLocation>
  </DeviceInfo>
  <S>
    <S1>
      <description>S1:TST1xx</description>
      <id>28C4C109030000C5</id>
      <item1>
        <value>14.9</value>
        <unit>°C</unit>
        <alarm>0</alarm>
        <min>-40.0</min>
        <max>85.0</max>
        <hys>8.5</hys>
      </item1>
      <item2>
        <value>---</value>
        <unit>---</unit>
        <alarm>0</alarm>
        <min>---</min>
        <max>---</max>
        <hys>---</hys>
      </item2>
    </S1>
    <S2>
      <description>S2:TSH2xx</description>
      <id>015225B71700FF45</id>
      <item1>
        <value>22.6</value>
        <unit>°C</unit>
        <alarm>0</alarm>
        <min>-40.0</min>
        <max>85.0</max>
        <hys>8.5</hys>
      </item1>
      <item2>
        <value>57.9</value>
        <unit>%RH</unit>
        <alarm>0</alarm>
        <min>0.0</min>
        <max>100.0</max>
        <hys>10.0</hys>
      </item2>
    </S2>
    <S3>
      <description>S3</description>
      <id>0000000000000000</id>
      <item1>
        <value>---</value>
        <unit>---</unit>
        <alarm>0</alarm>
        <min>---</min>
        <max>---</max>
        <hys>---</hys>
      </item1>
      <item2>
        <value>---</value>
```

```

        <unit>---</unit>
        <alarm>0</alarm>
        <min>---</min>
        <max>---</max>
        <hys>---</hys>
    </item2>
</S3>
<S4>
    <description>S4</description>
    <id>0000000000000000</id>
    <item1>
        <value>---</value>
        <unit>---</unit>
        <alarm>0</alarm>
        <min>---</min>
        <max>---</max>
        <hys>---</hys>
    </item1>
    <item2>
        <value>---</value>
        <unit>---</unit>
        <alarm>0</alarm>
        <min>---</min>
        <max>---</max>
        <hys>---</hys>
    </item2>
</S4>
</S>
<AI>
    <AI1>
        <description>Analog Input 1</description>
        <value>0.889</value>
        <unit>V</unit>
        <multiplier>1.000</multiplier>
        <offset>0.0000</offset>
        <alarm>0</alarm>
        <min>0.000</min>
        <max>2.000</max>
        <hys>0.500</hys>
    </AI1>
    <AI2>
        <description>Analog Input 2</description>
        <value>5.725</value>
        <unit>V</unit>
        <multiplier>1.000</multiplier>
        <offset>0.0000</offset>
        <alarm>1</alarm>
        <min>0.000</min>
        <max>2.000</max>
        <hys>0.500</hys>
    </AI2>
</AI>
<DI>
    <DI1>
        <description>Digital Input 1</description>
        <value>OPEN</value>
        <valuebin>1</valuebin>
        <alarmState>CLOSED</alarmState>
        <alarm>0</alarm>
    </DI1>
    <DI2>
        <description>Digital Input 2</description>
        <value>OPEN</value>
        <valuebin>1</valuebin>
        <alarmState>CLOSED</alarmState>
        <alarm>0</alarm>
    </DI2>
</DI>
</R>

```



```
<R1>
  <description>Relay 1</description>
  <value>in pulse</value>
  <valuebin>0</valuebin>
  <pulseWidth>5.0</pulseWidth>
  <control>0</control>
</R1>
<R2>
  <description>Relay 2</description>
  <value>ON</value>
  <valuebin>1</valuebin>
  <pulseWidth>2.0</pulseWidth>
  <control>0</control>
</R2>
</R>
<HTTPPush>
  <Key/>
  <PushPeriod>1</PushPeriod>
</HTTPPush>
<signalpercent>90</signalpercent>
<hwerr/>
<Alarmed>1</Alarmed>
<Scannig/>
<Time>
  <Date>05.02.2019</Date>
  <Time>11:47:51</Time>
</Time>
<NetworkInfo>
  <Name>Mobiltel EAD</Name>
  <SC>
    <MCC>284</MCC>
    <MNC>01</MNC>
    <LAC>28200</LAC>
    <CID>38208</CID>
    <SQ>-57</SQ>
  </SC>
</NetworkInfo>
</Monitor>
```

Appendix B

The JSON file structure:

```
{
  "Monitor": {
    "DeviceInfo": {
      "DeviceName": "TCG120",
      "HostName": "TCG120",
      "ID": "863071015406348",
      "FwVer": "v2.08",
      "MnfInfo": "www.teracomsystems.com",
      "SysContact": "info@teracomsystems.com",
      "SysName": "TCG120",
      "SysLocation": "Location"
    },
    "S": {
      "S1": {
        "description": "S1:TST1xx",
        "id": "28C4C109030000C5",
        "item1": {
          "value": "14.9",
          "unit": "°C",
          "alarm": "0",
          "min": "-40.0",
          "max": "85.0",
          "hys": "8.5"
        },
        "item2": {
          "value": "---",
          "unit": "---",
          "alarm": "0",
          "min": "---",
          "max": "---",
          "hys": "---"
        }
      },
      "S2": {
        "description": "S2:TSH2xx",
        "id": "015225B71700FF45",
        "item1": {
          "value": "22.6",
          "unit": "°C",
          "alarm": "0",
          "min": "-40.0",
          "max": "85.0",
          "hys": "8.5"
        },
        "item2": {
          "value": "57.9",
          "unit": "%RH",
          "alarm": "0",
          "min": "0.0",
          "max": "100.0",
          "hys": "10.0"
        }
      },
      "S3": {
        "description": "S3",
        "id": "0000000000000000",
        "item1": {
          "value": "---",
          "unit": "---",
          "alarm": "0",
          "min": "---",
          "max": "---",
          "hys": "---"
        }
      }
    }
  }
}
```

```

    "item2": {
      "value": "---",
      "unit": "---",
      "alarm": "0",
      "min": "---",
      "max": "---",
      "hys": "---"
    }
  },
  "S4": {
    "description": "S4",
    "id": "0000000000000000",
    "item1": {
      "value": "---",
      "unit": "---",
      "alarm": "0",
      "min": "---",
      "max": "---",
      "hys": "---"
    },
    "item2": {
      "value": "---",
      "unit": "---",
      "alarm": "0",
      "min": "---",
      "max": "---",
      "hys": "---"
    }
  }
},
"AI": {
  "AI1": {
    "description": "Analog Input 1",
    "value": "0.889",
    "unit": "V",
    "multiplier": "1.000",
    "offset": "0.0000",
    "alarm": "0",
    "min": "0.000",
    "max": "2.000",
    "hys": "0.500"
  },
  "AI2": {
    "description": "Analog Input 2",
    "value": "5.726",
    "unit": "V",
    "multiplier": "1.000",
    "offset": "0.0000",
    "alarm": "1",
    "min": "0.000",
    "max": "2.000",
    "hys": "0.500"
  }
},
"DI": {
  "DI1": {
    "description": "Digital Input 1",
    "value": "OPEN",
    "valuebin": "1",
    "alarmState": "CLOSED",
    "alarm": "0"
  },
  "DI2": {
    "description": "Digital Input 2",
    "value": "OPEN",
    "valuebin": "1",
    "alarmState": "CLOSED",
    "alarm": "0"
  }
}

```

```

},
"R": {
  "R1": {
    "description": "Relay 1",
    "value": "ON",
    "valuebin": "1",
    "pulseWidth": "5.0",
    "control": "0"
  },
  "R2": {
    "description": "Relay 2",
    "value": "ON",
    "valuebin": "1",
    "pulseWidth": "2.0",
    "control": "0"
  }
},
"HTTPPush": {
  "Key": "",
  "PushPeriod": "1"
},
"signalpercent": "80",
"hwerr": "",
"Alarmed": "1",
"Scannig": "",
"Time": {
  "Date": "05.02.2019",
  "Time": "12:11:02"
},
"NetworkInfo": {
  "Name": "Mobilitel EAD",
  "SC": {
    "MCC": "284",
    "MNC": "01",
    "LAC": "28200",
    "CID": "38449",
    "SQ": "-63"
  }
}
}
}
}

```

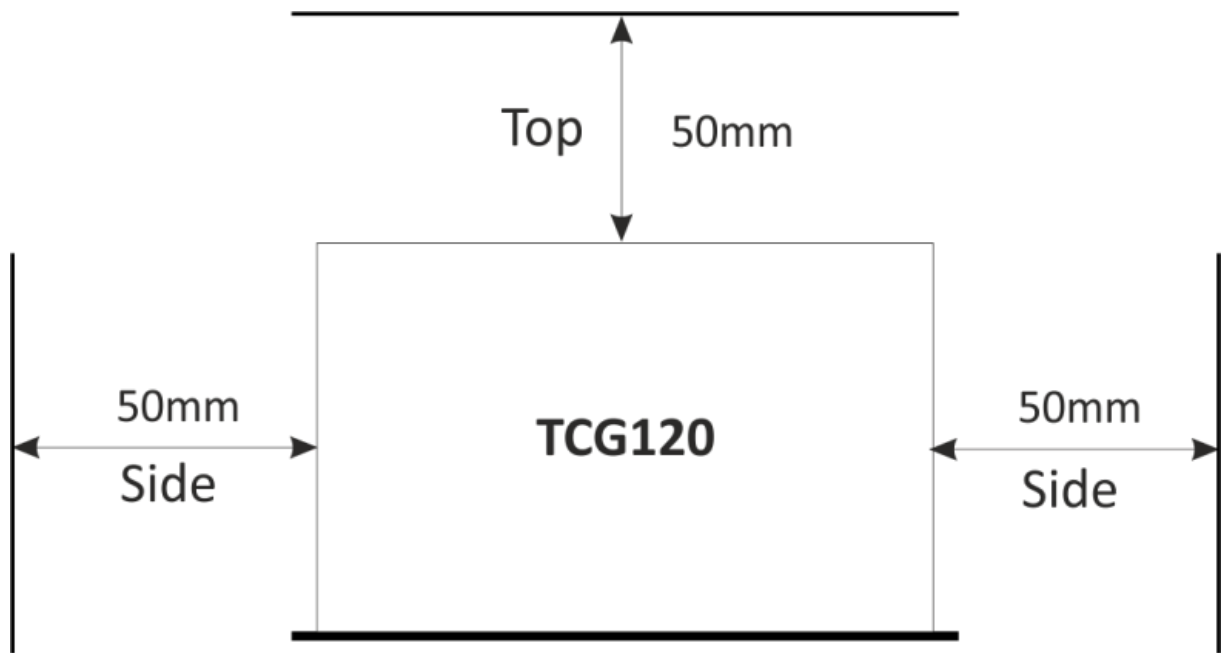

Fig.1

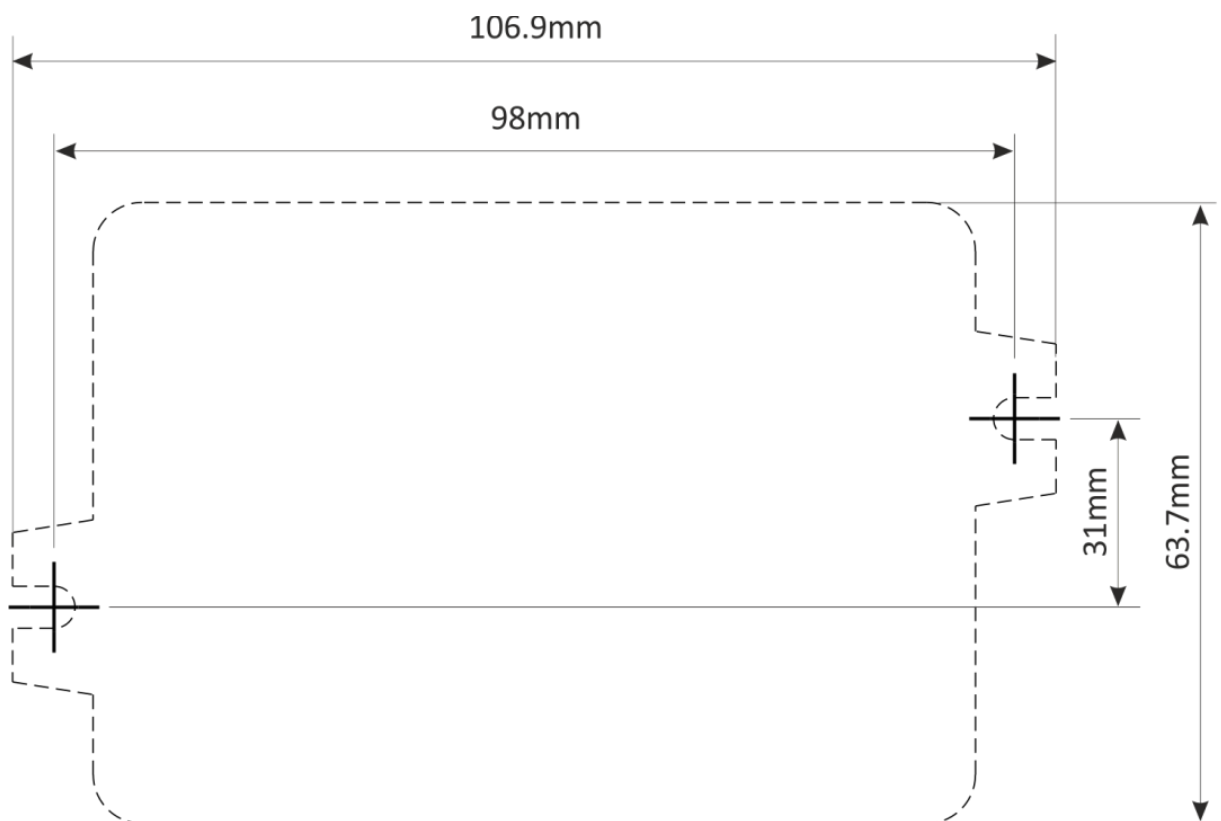

Fig.2